

# Standard Elastomeric Bearings

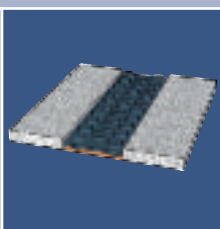
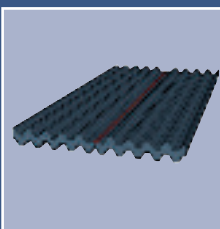
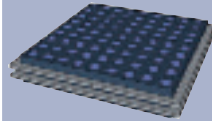
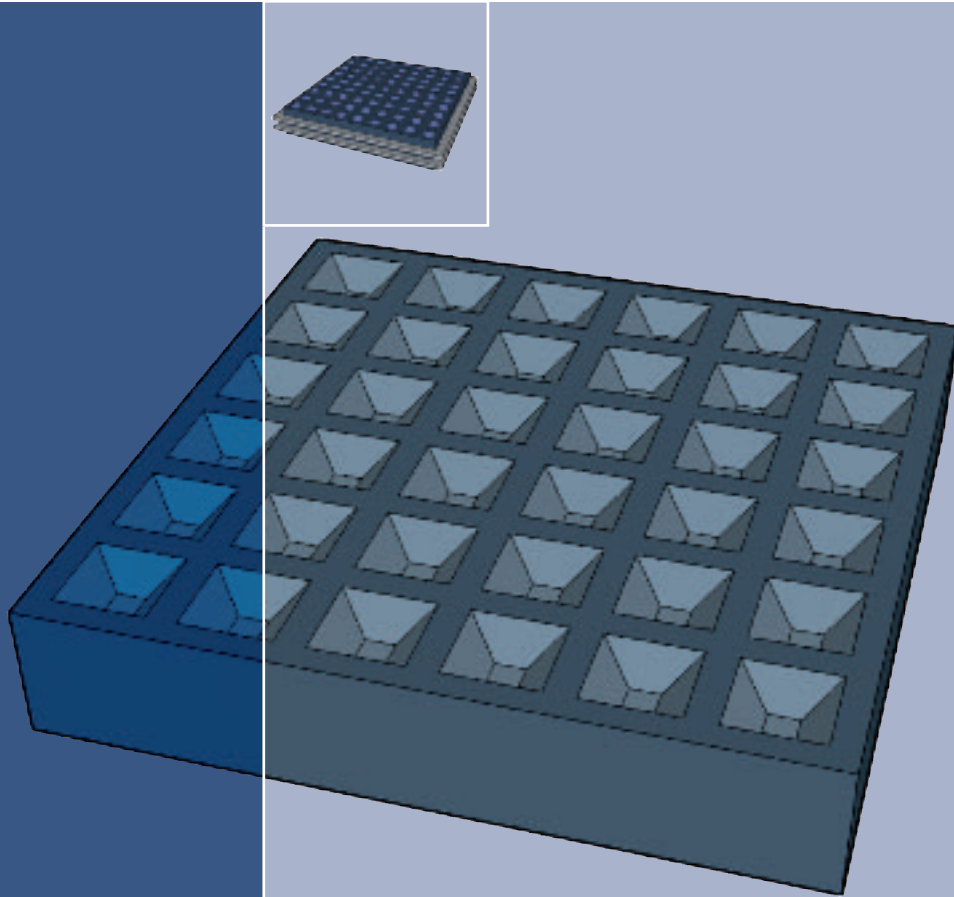

*Elastic support of structural members subject to static loading*

*Scope and dimensioning guidelines*

# Standard Elastomeric Bearings

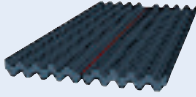
Bearing type	Bearing thickness [mm]	Permissible compressive stress $\sigma_{m,k}^{**}$ [N/mm <sup>2</sup> ]	Product description	
<b>bi-Trapez Bearing®</b>	5 10 15 20	<b>15</b> <b>10</b> <b>7</b> <b>5</b>	Unreinforced elastomeric bearing, shape independent loadability, quality controlled material; Official Certificate No. P-849.0554/1	
<b>Cigular® Bearing</b>	10	<b>1,1</b>	Low shear resistant deforming bearing, thermally insulated, for supporting reinforced concrete floor slab on load bearing structures; Official Certificate No. P-20040369	
<b>Ciparall® Sliding Bearing</b>	11 14 20 30 40	<b>15*</b>	Reinforced elastomeric sliding bearing with separated sliding and deforming layer (stable sliding area); Official Certificate No. P-852.0290-4	
<b>Civalit® Sliding Bearing</b>	11	<b>15</b>	Transverse tensile reinforced strip sliding bearing (stable sliding area); Official Certificate No. P-20041090	
<b>Compact Bearing CR 2000</b>	11 16 21	<b>20*</b>	Unreinforced elastomeric bearing; Official Certificate No. 850.0425; Official Approval No. Z-16.32-435	

\* permissible compressive stress as f (shape factor)

\*\* characteristic design values

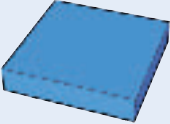
Bearing type	Bearing thickness [mm]	Permissible compressive stress $\sigma_{m,k}^{**}$ [N/mm <sup>2</sup> ]	Product description	
<b>Compact Bearing G</b>	5 10 15 20	<b>5*</b>	Unreinforced elastomeric bearing; Official Approval No. Z-16.32-426	
<b>Compact Bearing S 70</b>	5 8 10 15 20	<b>15*</b>	Unreinforced elastomeric bearing; Official Certificate No. 850.0427	
<b>Compact Bearing S 65</b>	5 8 10 15 20 25 30	<b>10*</b>	Unreinforced elastomeric bearing; Official Certificate No. 851.0364	
<b>Compression Bearing</b>	5 10 15 20	<b>5*</b>	Unreinforced elastomeric bearing; Official Certificate No. P-852.0290-6	
<b>Perforated™ Bearing 205</b>	5 8	<b>25*</b>	Perforated unreinforced elastomeric bearing; Official Certificate No. P-852.0290-1	

\* permissible compressive stress as  $f$  (shape factor)

\*\* characteristic design values

# Standard Elastomeric Bearings

# Standard Elastomeric Bearings

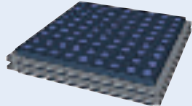
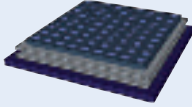
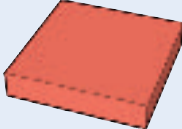
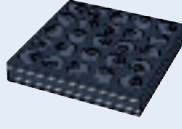
Bearing type	Bearing thickness [mm]	Permissible compressive stress $\sigma_{m,k}^{**}$ [N/mm <sup>2</sup> ]	Product description	
<b>Perforated™ Bearing Steel Reinforced</b>	14 20 22 30 31 38 42 53	<b>25*</b>	Steel reinforced elastomeric bearing; Official Certificate No. P-852.0290-1	
<b>Perforated™ Sliding Bearing</b>	14 17 22 28 30 38 39 50	<b>25*</b>	Steel reinforced elastomeric sliding bearing with separated sliding and deforming layer (stable sliding area); Official Certificate No. P-852.0290-1	
<b>Compact Core Bearing</b>	5 10 15 20	<b>30*</b>	Elastomeric bearing of high hardness with small deflection, suitable to provide thermal insulation in steel constructions; Official Certificate No. P-852.0448	
<b>Sandwich Bearing Q</b>	10 20 30 40	<b>15*</b>	Steel reinforced elastomeric bearing; Official Certificate No. P-852.0290-3	

\* permissible compressive stress as f (shape factor)

\*\* characteristic design values

Since 1964 Calenberg Elastomeric bearings have been employed where compressive forces, angular rotations and horizontal forces affect structural element junctions and can damage the construction. Elastomeric bearings are virtually incompressible, i. e. even under load they hold a constant volume. When a vertical load is applied to an elastomeric bearing, it deflects and bulges laterally. This behaviour can be reduced by inserting steel plates. Increasing environmental impact requires higher ageing resistance of the construction materials.

All of Calenberg's elastomeric bearings have been certificated to meet the standards regarding resistance to weathering, ozone and UV.

For the dimensioning of unreinforced elastomeric bearings the shape factor  $S$  – ratio of loaded area to unloaded laterally bulging area – has proven to be useful (see equations below).

The auxiliary values in the table on page 6 allow users to quickly determine the shape factor. The values are a function of the bearing's physical dimensions (length and width). The value determined is then divided by the required bearing thickness. The shape factor  $S$  obtained is used as an input parameter for the graph on page 7, which shows unreinforced Calenberg elastomeric bearings for preselection purpose. The other required input parameter is the existing compressive stress. The required type of bearing can then be read off the graph; it is indicated by the line above the intersection point of the two entered values.

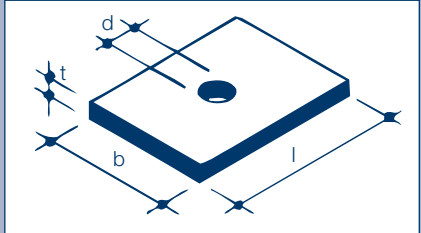

without hole:  $S = \frac{l \cdot b}{2 \cdot t \cdot (l + b)}$

with hole:  $S = \frac{4 \cdot l \cdot b - \pi \cdot d^2}{4 \cdot t \cdot (2 \cdot l + 2 \cdot b + \pi \cdot d)}$

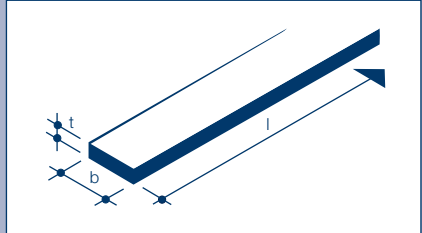

$S \approx \frac{b}{2 \cdot t}$

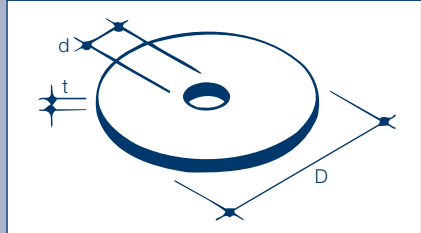

without hole:  $S = \frac{D}{4 \cdot t}$

with hole:  $S = \frac{D - d}{4 \cdot t}$

# Dimensioning of Elastomeric Bearings

# Auxiliary Values for Shape Factors

Bearing width [mm]	Bearing length [mm]																																									
	100	110	120	130	140	150	160	170	180	190	200	210	220	230	240	250	260	270	280	290	300	310	320	330	340	350	360	370	380	390	400											
100	25	26	27	28	29	30	31	31	32	33	33	34	34	35	35	36	36	36	37	37	38	38	38	38	39	39	39	39	40	40	40	40	40	40	40	40	40	40				
110	26	28	29	30	31	32	33	33	34	35	35	36	37	37	38	38	39	39	39	40	40	40	41	41	41	42	42	42	42	43	43	43	43	43	43	43	43	43	43	43		
120	27	29	30	31	32	33	34	35	36	37	38	38	39	39	40	41	41	42	42	42	43	43	44	44	44	45	45	45	46	46	46	46	46	46	46	46	46	46	46	46		
130	28	30	31	33	34	35	36	37	38	39	39	40	41	42	42	43	43	44	44	45	45	46	46	47	47	47	48	48	48	49	49	49	49	49	49	49	49	49	49	49		
140	29	31	32	34	35	36	37	38	39	40	41	42	43	44	44	45	46	47	48	48	49	49	50	51	51	52	52	53	53	53	54	54	54	54	54	54	54	54	54	54		
150	30	32	33	35	36	38	39	40	41	42	43	44	45	46	47	48	49	50	51	52	52	53	53	54	54	55	55	56	56	56	57	57	57	57	57	57	57	57	57	57	57	
160	31	33	34	36	37	39	40	41	42	43	44	45	46	47	48	49	50	50	51	52	52	53	53	54	54	55	55	56	56	56	57	57	58	58	58	58	58	58	58	58	58	
170	31	33	35	37	38	40	41	43	44	45	46	47	48	49	50	51	51	52	53	54	54	55	56	56	57	57	58	58	59	59	59	59	60	61	61	62	62	62	62	62	62	
180	32	34	36	38	39	41	42	44	45	46	47	48	50	50	51	52	53	54	55	56	56	57	58	58	59	59	60	60	61	62	62	63	63	64	64	65	65	66	66	66	66	
190	33	35	37	39	40	42	43	45	46	48	49	50	51	52	53	54	55	56	57	57	58	59	60	60	61	62	62	63	64	64	65	66	66	67	67	68	68	69	69	69	69	
200	33	35	38	39	41	43	44	46	47	49	50	51	52	53	55	56	57	57	58	59	60	61	62	62	63	64	64	65	66	66	67	68	68	69	70	70	71	71	71	71	71	
210	34	36	38	40	42	44	45	47	48	50	51	53	54	55	56	57	58	59	60	61	62	63	63	64	65	66	66	67	68	68	69	70	70	71	72	72	73	73	73	73	73	
220	34	37	39	41	43	45	46	48	50	51	52	54	55	56	57	59	60	61	62	63	63	64	65	66	67	68	68	69	70	70	71	72	72	73	74	74	75	75	75	75	75	
230	35	37	39	42	44	45	47	49	50	52	53	55	56	58	59	60	61	62	63	64	65	66	67	68	69	69	70	71	71	72	72	73	74	74	75	75	76	76	76	76	76	
240	35	38	40	42	44	46	48	50	51	53	55	56	57	59	60	61	62	64	65	66	67	68	69	69	70	71	72	73	74	74	75	75	76	77	77	78	78	78	78	78	78	
250	36	38	41	43	45	47	49	51	52	54	56	57	59	60	61	63	64	65	66	67	68	69	70	71	72	73	74	75	76	77	77	78	79	79	80	80	81	81	81	81	81	
260	36	39	41	43	46	48	50	51	53	55	57	58	60	61	62	64	65	66	67	69	70	71	72	73	74	75	76	77	78	79	80	80	81	82	82	83	83	84	84	84	84	
270	36	39	42	44	46	48	50	52	54	56	57	59	61	62	64	65	66	68	69	70	71	72	73	74	75	76	77	78	79	80	81	81	82	83	83	84	84	85	85	85	85	
280	37	39	42	44	47	49	51	53	55	57	58	60	62	63	65	66	67	69	70	71	72	74	75	76	77	78	79	80	81	81	82	83	83	84	84	85	85	86	86	86	86	
290	37	40	42	45	47	49	52	54	56	57	59	61	63	64	66	67	69	70	71	73	74	75	76	77	78	79	80	81	82	82	83	84	84	85	85	86	86	87	87	87	87	
300	38	40	43	45	48	50	52	54	56	58	60	62	63	65	67	68	70	71	72	74	75	76	77	79	80	81	82	83	84	84	85	86	86	87	87	88	88	89	89	89	89	
310	38	41	43	46	48	51	53	55	57	59	61	63	64	66	68	69	71	72	74	75	76	78	79	80	81	82	83	84	85	85	86	87	87	88	88	89	89	90	90	90	90	
320	38	41	44	46	49	51	53	56	58	60	62	63	65	67	69	70	72	73	75	76	77	79	80	81	82	84	85	86	87	87	88	89	89	90	90	91	91	91	91	91		
330	38	41	44	47	49	52	54	56	58	60	62	64	66	68	69	71	73	74	76	77	79	80	81	83	84	85	86	87	88	88	89	89	90	90	91	91	92	92	92	92		
340	39	42	44	47	50	52	54	57	59	61	63	65	67	69	70	72	74	75	77	78	80	81	82	84	85	86	87	89	89	90	91	91	92	92	93	93	93	93	93	93		
350	39	42	45	47	50	53	55	57	59	62	64	66	68	69	71	73	75	76	78	79	81	82	84	85	86	88	89	90	91	91	92	92	93	93	94	94	94	94	94	94	94	
360	39	42	45	48	50	53	55	58	60	62	64	66	68	70	72	74	75	77	79	80	82	83	85	86	87	89	90	91	91	92	93	93	94	94	95	95	95	95	95	95	95	95
370	39	42	45	48	51	53	56	58	61	63	65	67	69	71	73	75	76	78	80	81	83	84	86	87	89	90	91	92	93	93	94	94	95	95	96	96	96	96	96	96	96	96
380	40	43	46	48	51	54	56	59	61	63	66	68	70	72	74	75	77	79	81	82	84	85	87	88	90	91	92	93	94	94	95	95	96	96	97	97	97	97	97	97	97	97
390	40	43	46	49	52	54	57	59	62	64	66	68	70	72	74	76	78	80	81	83	85	86	88	89	91	92	94	95	96	96	97	97	98	98	98	98	98	98	98	98	98	98
400	40	43	46	49	52	55	57	60	62	64	67	69	71	73	75	77	79	81	82	84	86	87	89	90	92	93	95	96	97	97	99	99	100	100	100	100	100	100	100	100	100	100

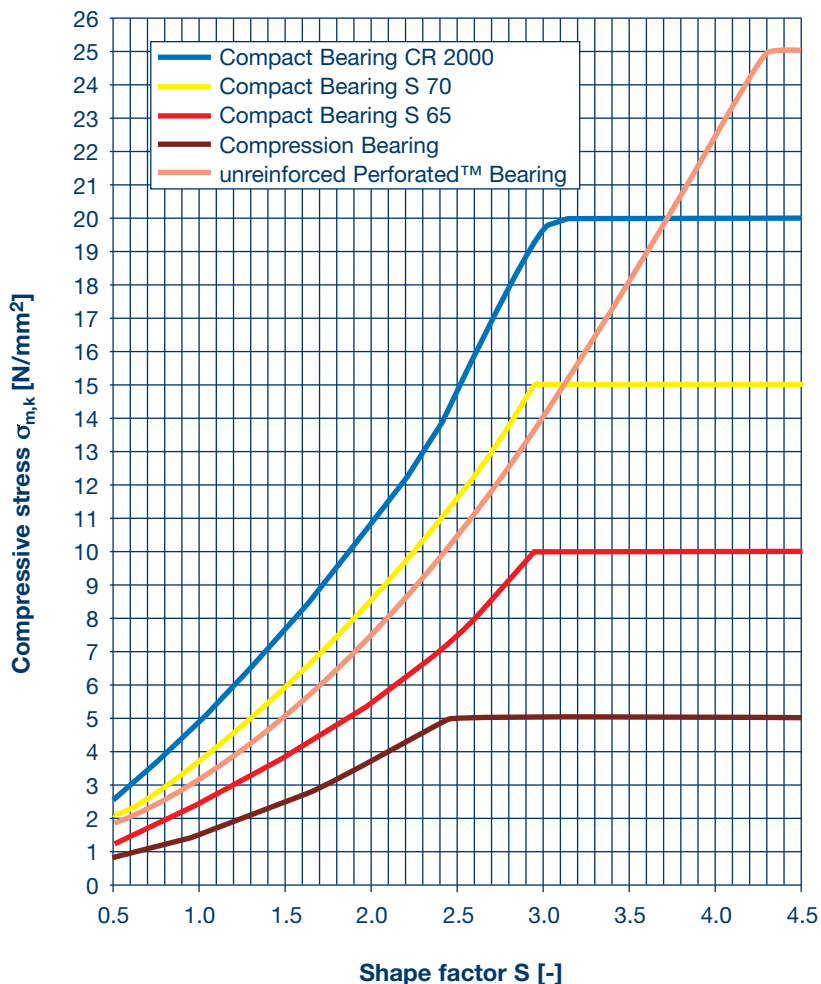

**Example:**

Existing compressive stress  $\sigma_{m,k}$ : 7 N/mm<sup>2</sup>  
 Selected bearing length l: 120 mm  
 Selected bearing width b: 120 mm  
 Selected bearing thickness t: 15 mm

Auxiliary value from table on page 6: 30

Shape factor S:

$$S = \frac{\text{Aux. value table on page 6}}{\text{Selected bearing thickness}} = \frac{30}{15} = 2$$

From the graph on the left hand side:

Compact Bearing S 70

The unreinforced Perforated Bearing cannot be used as it is not available in the required thickness of 15 mm i.e. it needs to be checked if the required bearing thickness is available or the next possible bearing thickness has to be chosen.

The exact design is carried out according to the product information.

# Choice of Bearing by Shape Factor

# Edge Distances

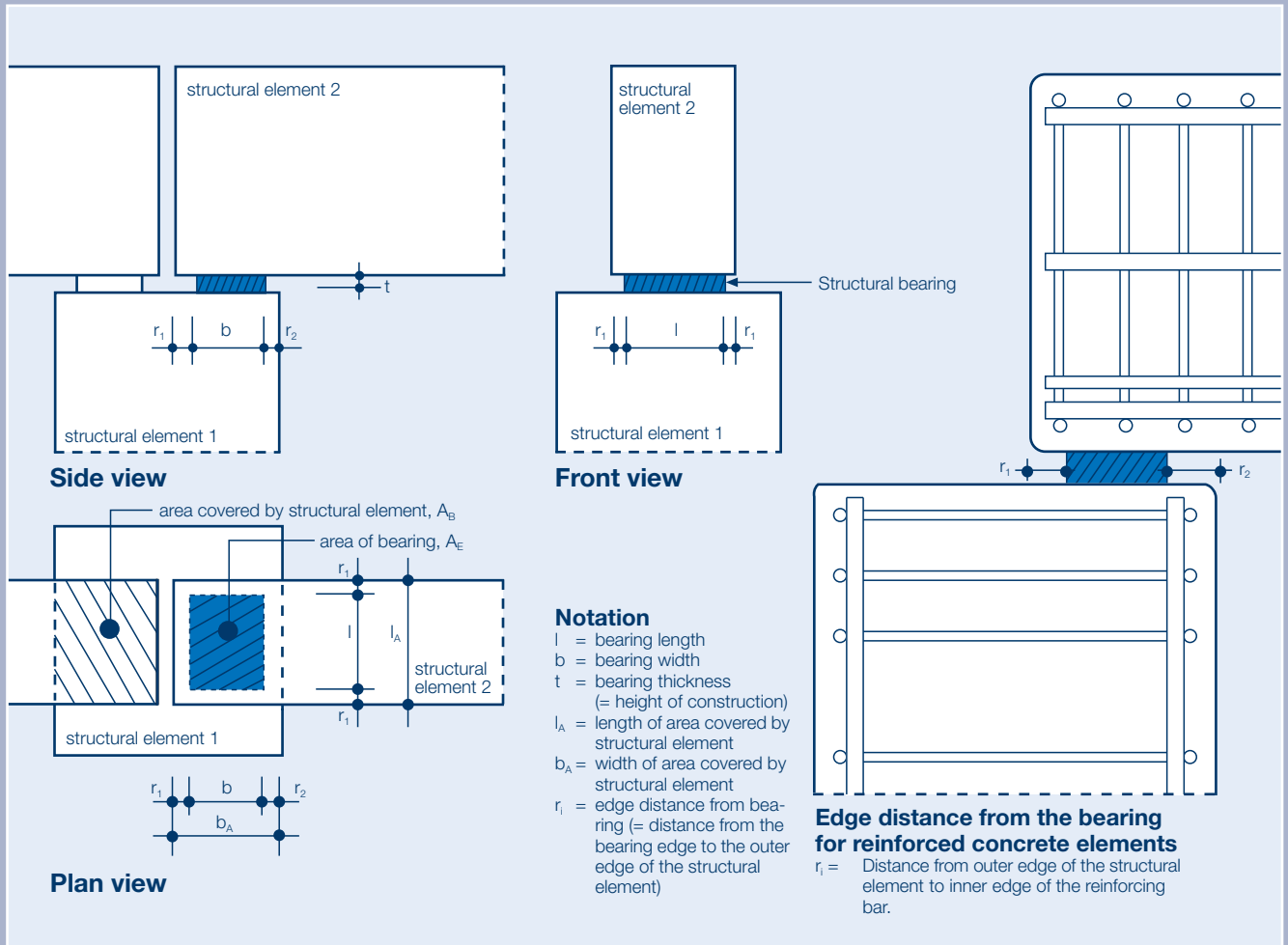

Maximum size of plan area of an elastomeric bearing for reinforced concrete construction (edge distance). DIN 1045-1 and Heft 525 of the DAfStb (German Committee for Structural Concrete) are to be adhered to. For timber or steel members the edge distance shall be at least 3 cm.

The contents of this publication are the result of many years of research and experience gained in application technology. All information is given in good faith; it does not represent a guarantee with respect to characteristics and does not exempt the user from testing the suitability of products and from ascertaining that the industrial property rights of third parties are not violated. No liability whatsoever will be accepted for damage – regardless of its nature and its legal basis – arising from advice given in this publication. This does not apply in the event that we or our legal representatives or management are found guilty of having acted with intent or gross negligence. No liability is borne for damage due to ordinary negligence. This exclusion of liability applies also to the personal liability of our legal representatives and employees and other persons employed in performing our obligations.

**Calenberg Ingenieure,**  
**planmäßig elastisch lagern GmbH**  
Am Knübel 2-4  
D-31020 Salzhemmendorf / Germany  
Phone +49 (0) 51 53/94 00-0  
Fax +49 (0) 51 53/94 00-49  
info@calenberg-ingenieure.de  
http://www.calenberg-ingenieure.de